

ORNAMENT  
MARBLE  
CEMENT  
**STONE**  
WOOD  
OPUS

■  
CAPRI

Rev.01

 **PADUA**  
REDEFINE  
PERFECTION

ORNAMENT  
MARBLE  
CEMENT  
**STONE**  
WOOD  
OPUS  
■  
CAPRI



“

Harmonious, meticulously detailed surfaces with impressive technical and aesthetic properties: PADUA designs floor and wall coverings, not tiles.

”

## **CAPRI**

CAPRI came to life after a long search and after many attempts to mix three stones of different nature. In the end we managed to find the right mix: the Italian Collemantina marble, the French Imperiale marble and the slate from the Trentino-Alto-Adige Alps.



## THICKNESS 2

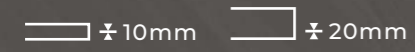

## FORMATS 4

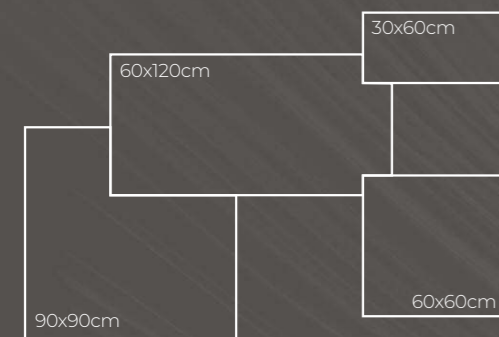

The company's mastery of production processes and extensive research and development take its products beyond all expectations, towards an aesthetic ideal that is always up-to-date, realized in collections that defy fashion, synonymous with beauty that continues to express itself over time.

## COLOURS 5



GLACIER



SALT



NUTMEG



EARL GREY



PEPPER

## SURFACES 2



IN&OUT  
**MATT**

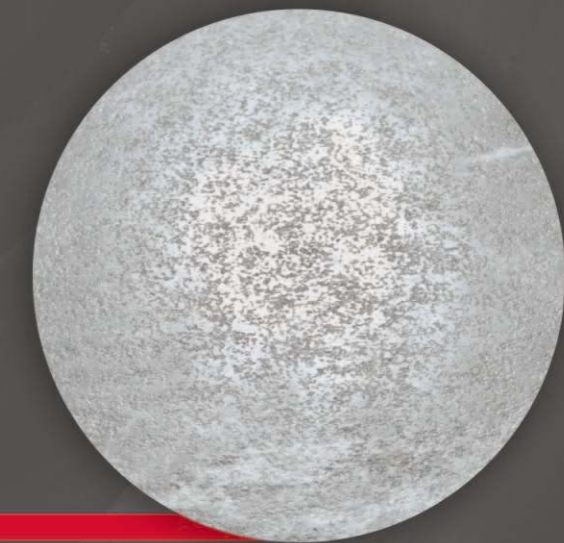

LAPPATO

# “ CAPRI GLACIER



- PD36190**  
▲ 30 x 60CM | 12" x 24"
- PD126190**  
◀ 60 x 120CM | 24" x 48"
- PD6190**  
▼ 60 x 60CM | 24" x 24"

**PD9190**  
▲ 90 x 90CM | 36" x 36"



**TUMBLLED EDGE MOSAIC**  
CPSM90  
29.8 x 32.7CM



**TUMBLLED EDGE SUBWAY**  
CP1290  
10 x 20CM



2CM PAVER

**PD6190H**  
▲ 60 x 60CM | 24" x 24"  
■ 2cm



Pencil Edge Bullnose

**CPPB90**  
▲ 40 x 60CM | 16" x 24"  
■ 2cm





WALL: TUMBLED EDGE SUBWAY CP1290 10 x 20CM



FLOOR: GLACIER PD6190 30 x 60CM 60 x 60CM



WALL: GLACIER PD126190 20x120CM 60x120CM FLOOR: GLACIER PD126190 60x120CM



FLOOR: GLACIER PD9190 90x90CM

# “ CAPRI SALT



- PD36191**  
▲ 30 x 60CM | 12" x 24"
- PD126191**  
◀ 60 x 120CM | 24" x 48"
- PD6191**  
▼ 60 x 60CM | 24" x 24"

- PD9191**  
▲ 90 x 90CM | 36" x 36"



**TUMBLED EDGE MOSAIC**  
CPSM91  
29.8 x 32.7CM



**TUMBLED EDGE SUBWAY**  
CP1291  
10 x 20CM



**2CM PAVER**

**PD6191H**  
▲ 60 x 60CM | 24" x 24"  
■ 2cm



**Pencil Edge Bullnose**

**CPPB91**  
▲ 40 x 60CM | 16" x 24"  
■ 2cm

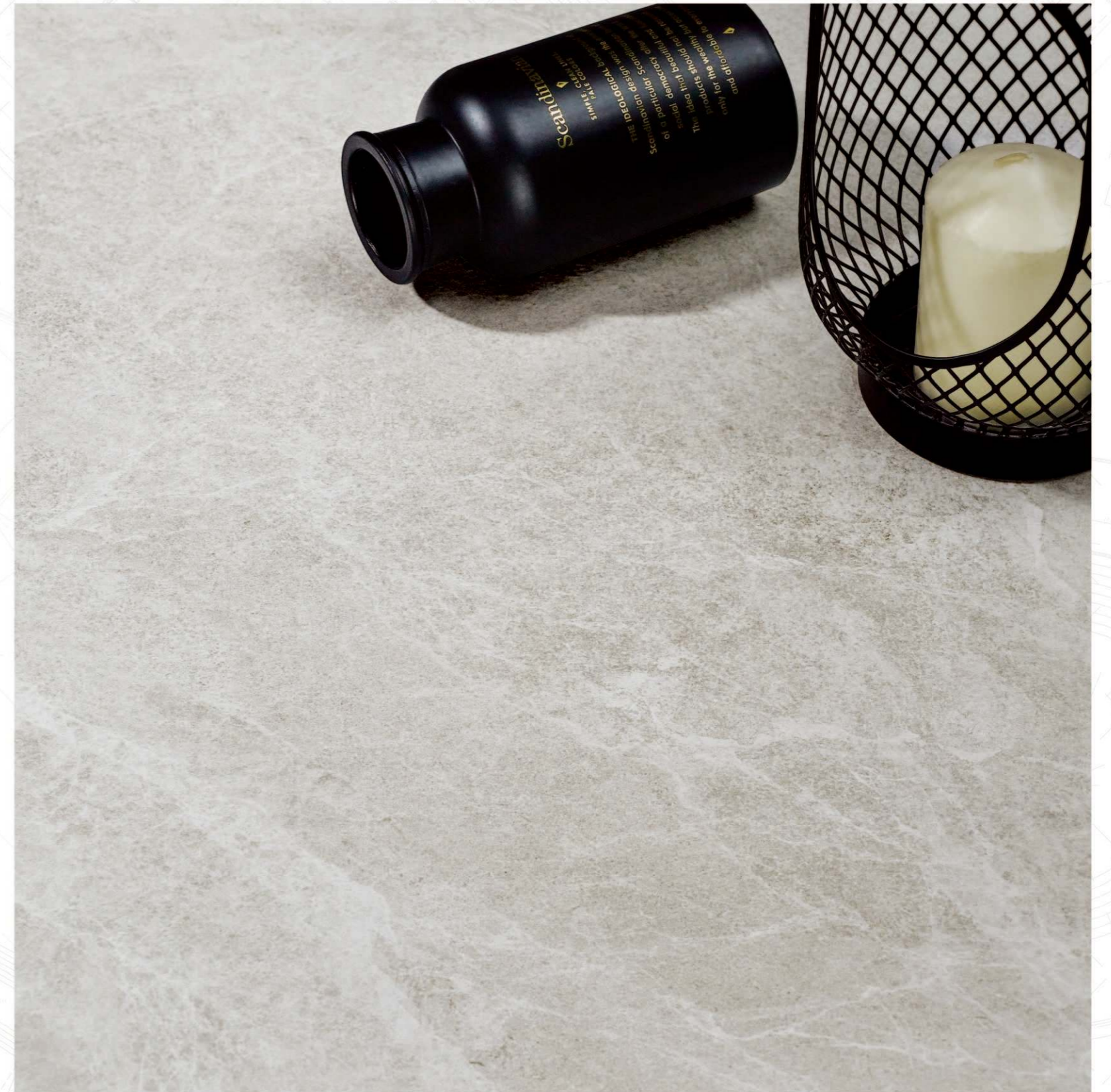



FLOOR: SALT PD6191 60 X 60CM



FLOOR: SALT PD126191 60 X 120CM





WALL: TUMBLED EDGE MOSAIC 29.8 X 32.7CM FLOOR: SALT PD9191 90 X 90CM

“  
CAPRI  
SALT



WALL: TUMBLED EDGE SUBWAY CP1291 10 X 20CM



“  
CAPRI  
**NUTMEG**

**PD36192**  
▲ 30 x 60CM | 12" x 24"

**PD126192**  
◀ 60 x 120CM | 24" x 48"

**PD6192**  
▼ 60 x 60CM | 24" x 24"

**PD9192**  
▲ 90 x 90CM | 36" x 36"



**TUMBLED EDGE MOSAIC**  
CPSM92  
29.8 x 32.7CM



**TUMBLED EDGE SUBWAY**  
CP1292  
10 x 20CM



**2CM PAVER**

**PD6192H**  
▲ 60 x 60CM | 24" x 24"  
■ 2cm

**Pencil Edge Bullnose**

**CPPB92**  
▲ 40 x 60CM | 16" x 24"  
■ 2cm

“  
CAPRI  
**NUTMEG**

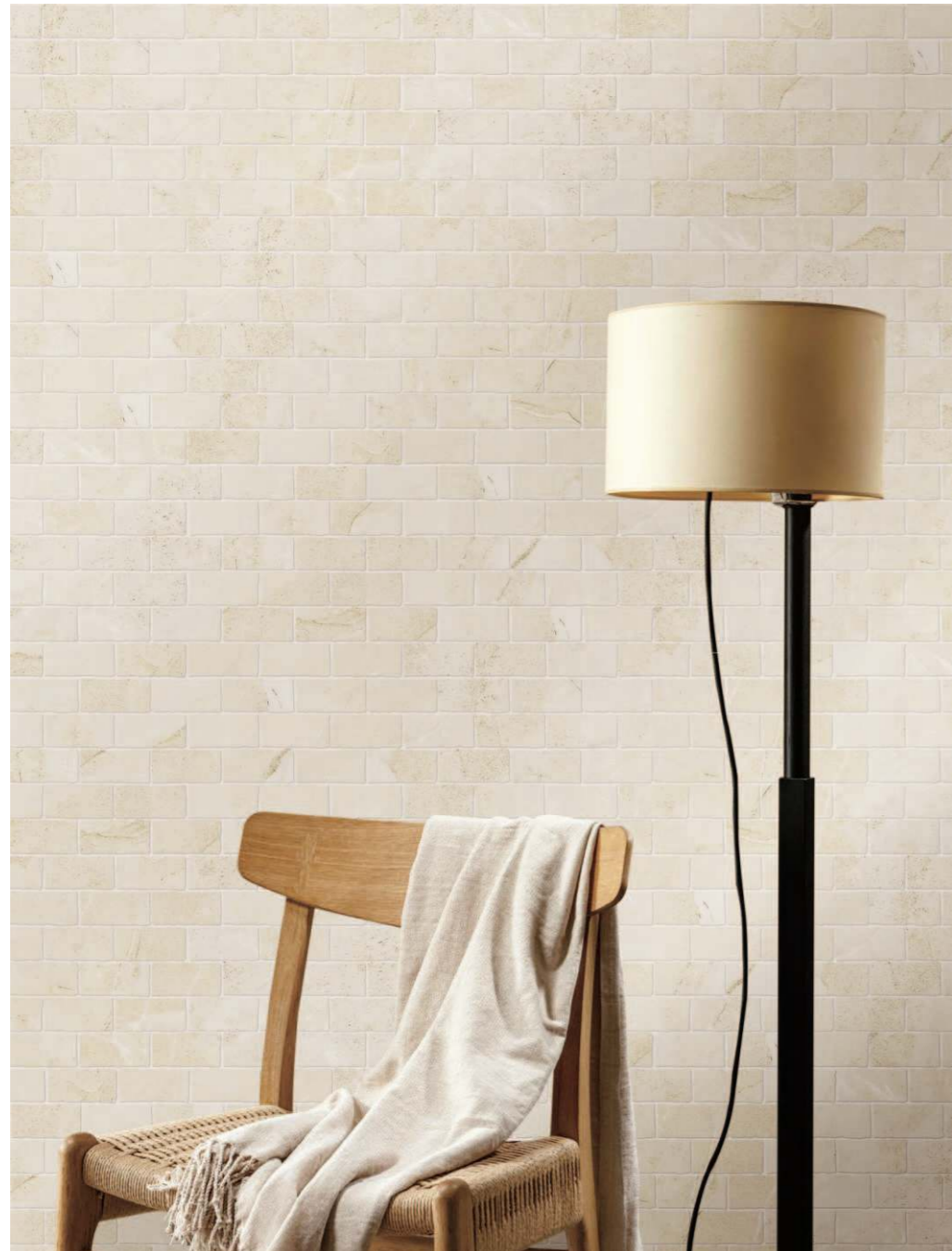

FLOOR: TUMBLED EDGE MOSAIC CPSM92 29.8 X 32.7CM



WALL/FLOOR: NUTMEG PD126192 60 X 120CM



FLOOR: NUTMEG PD9192 90 X 90CM



WALL: TUMBLED EDGE SUBWAY CP1292 10 X 20CM FLOOR: NUTMEG PD6192 60 X 60CM

“  
CAPRI  
**EARL GREY**



- PD36193**  
▲ 30 x 60CM | 12" x 24"
- PD126193**  
◀ 60 x 120CM | 24" x 48"
- PD6193**  
▼ 60 x 60CM | 24" x 24"

**PD9193**  
▲ 90 x 90CM | 36" x 36"



**TUMBLLED EDGE MOSAIC**  
CPSM93  
29.8 x 32.7CM



**TUMBLLED EDGE SUBWAY**  
CP1293  
10 x 20CM



**2CM PAVER**

**PD6193H**  
▲ 60 x 60CM | 24" x 24"  
■ 2cm

**Pencil Edge Bullnose**

**CPPB93**  
▲ 40 x 60CM | 16" x 24"  
■ 2cm





WALL: TUMBLED EDGE MOSAIC CPSM93 29.8 X 32.7CM FLOOR: EARL GREY PD126193 60 X 120CM



Lappato

FLOOR: EARL GREY PD6193P 60 X 60CM



WALL: EARL GREY PD36193 30 X 60CM

Slate is the strong and gritty component, an iconic and layered stone that we used to form the basis of the project. To enrich the design we have integrated the defined and elegant veins of the Collemandina in the foreground and later the complex and elaborate grid of the fine veins of the Imperiale.



WALL/FLOOR: EARL GREY PD126193 60 X 120CM



FLOOR: TUMBLED EDGE SUBWAY CP1293 10 X 20CM



FLOOR: EARL GREY PD9193 90 X 90CM





“  
CAPRI  
PEPPER

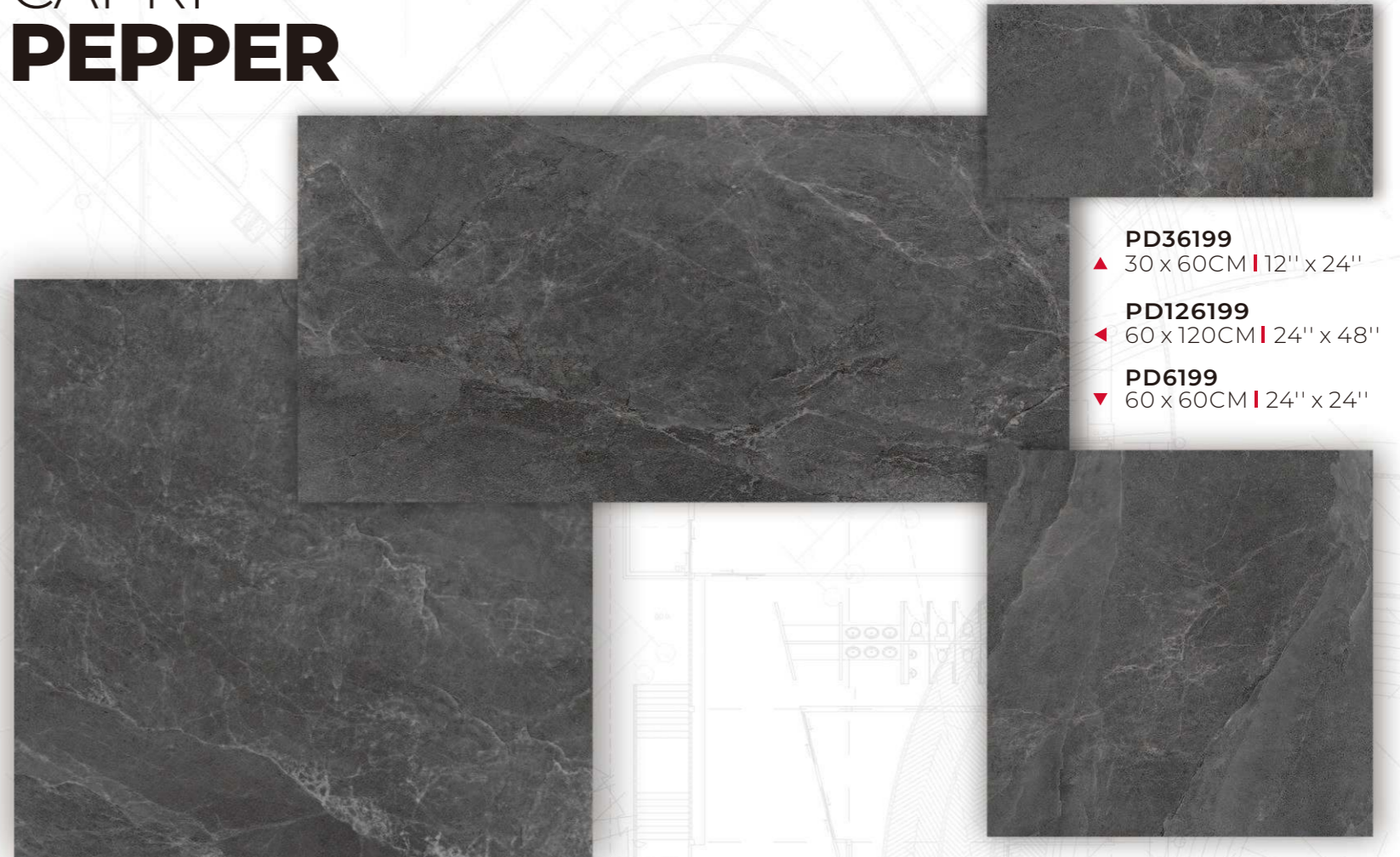

- PD36199**  
▲ 30 x 60CM | 12" x 24"
- PD126199**  
◀ 60 x 120CM | 24" x 48"
- PD6199**  
▼ 60 x 60CM | 24" x 24"

**PD9199**  
▲ 90 x 90CM | 36" x 36"



**TUMBLED EDGE MOSAIC**  
CPSM99  
29.8 x 32.7CM



**TUMBLED EDGE SUBWAY**  
CP1299  
10 x 20CM

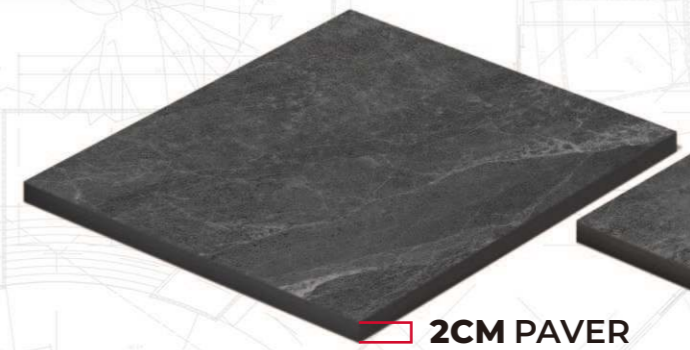

**2CM PAVER**  
**PD6199H**  
▲ 60 x 60CM | 24" x 24"  
■ 2cm



**Pencil Edge Bullnose**  
**CPPB99**  
▲ 40 x 60CM | 16" x 24"  
■ 2cm



WALL/FLOOR: PEPPER PD126199 60 X 120CM



FLOOR: PEPPER PD126199 60 X 120CM



FLOOR: PEPPER PD9199 90 X 90CM



WALL: PEPPER PD6199 30 X 7.5CM

WALL: TUMBLED EDGE SUBWAY CP1299 10 X 20CM

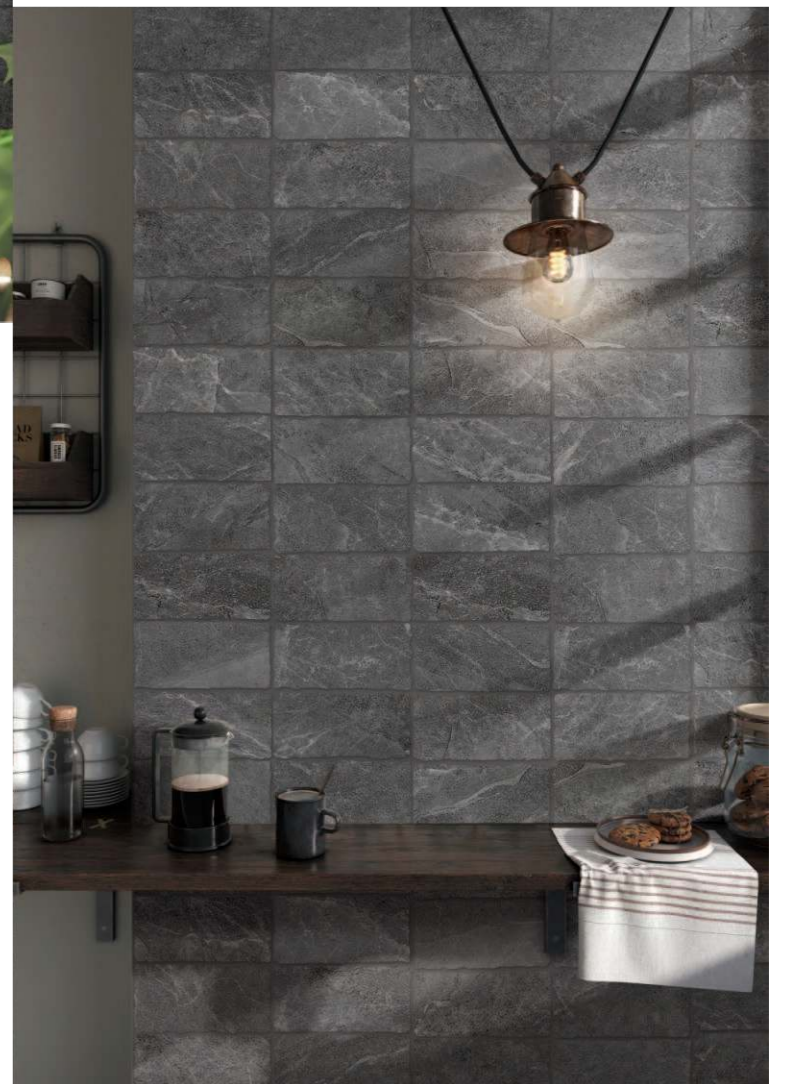

“  
CAPRI  
**PEPPER**



FLOOR: PEPPER PD6199 60 X 60CM



WALL: TUMBLED EDGE MOSAIC CPSM99 29.8 X 32.7CM FLOOR: PEPPER PD126199 60 X 120CM



“ CAPRI  
**OUTDOOR**

Padua Ceramics builds on its many years of expertise in the field of research and production of ceramic materials, and constant interaction with architects, designers and consumers, offering them a mature and stable coating technology with innovative and highly advanced features.



Pencil Edge Bullnose  
40x60cm  
2cm

FLOOR: GLACIER PD6190H 60 X 60 X 2CM PAVER



FLOOR: SALT PD6191H 60 X 60 X 2CM PAVER



FLOOR: NUTMEG PD6192H 60 X 60 X 2CM PAVER

**PAVER**  
OUTDOOR MATERIALS BY PADUA CERAMICS

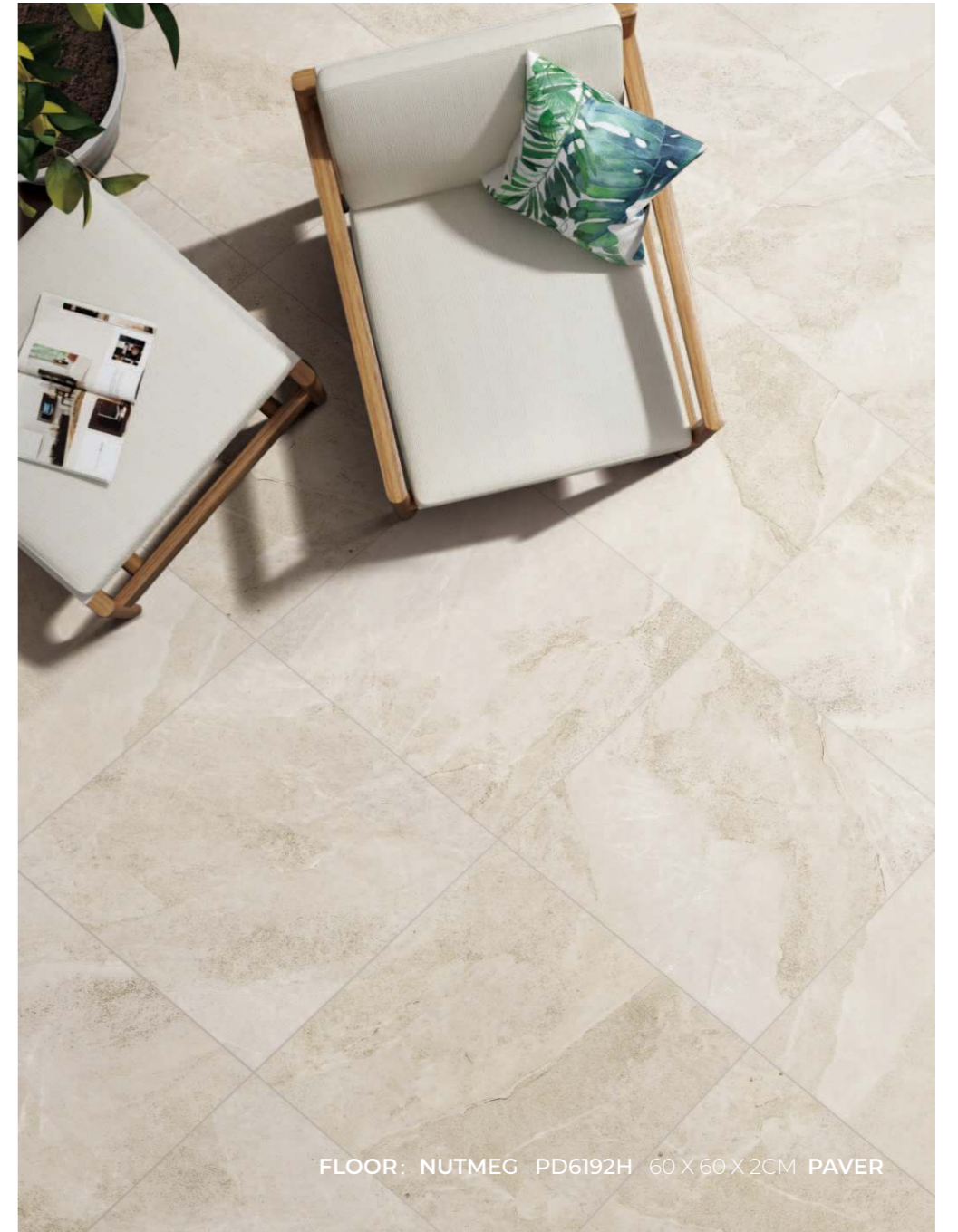

FLOOR: NUTMEG PD6192H 60 X 60 X 2CM PAVER



**PAVER**  
OUTDOOR MATERIALS BY PADUA CERAMICS

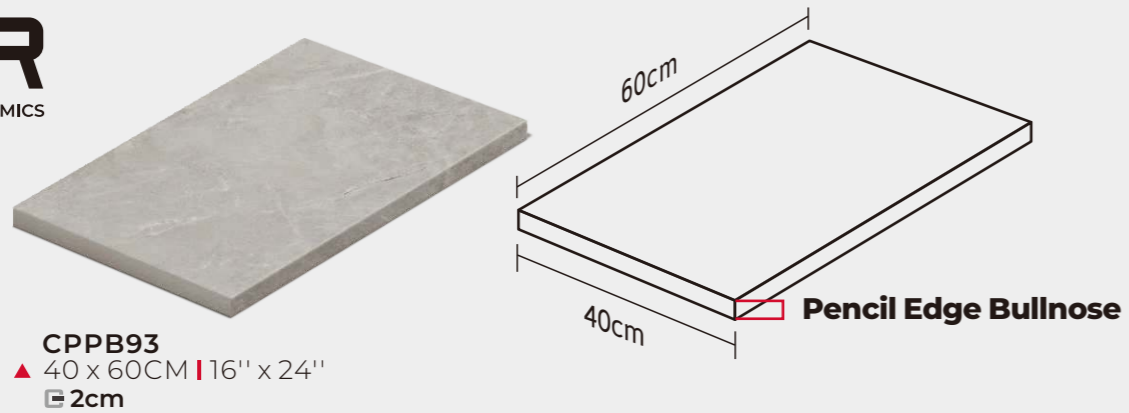

**CPPB93**  
▲ 40 x 60CM | 16" x 24"  
■ 2cm



FLOOR: EARL GREY PD6193H 60 X 60 X 2CM PAVER





FLOOR: EARL GREY PD6193H 60 X 60 X 2CM PAVER



FLOOR: PEPPER PD6199H 60 X 60 X 2CM PAVER

## TECHNICAL SPECIFICATIONS

TECHNICAL CHARACTERISTIC	STANDARD TEST METHOD	PRESCRIBED VALUES	PADUA VALUES
<b>MEASUREMENT &amp; SURFACE APPEARANCE</b>			
LENGTH	EN ISO 10545-2	±0.6%	±0.1%
WIDTH	EN ISO 10545-2	±0.6%	±0.1%
THICKNESS	EN ISO 10545-2	±5%	±3%
TRANSMUTATION	EN ISO 10545-2	±0.5%	±0.2%
<b>PHYSICAL PROPERTIES</b>			
WATER ABSORPTION	EN ISO 10545-3	≤0.5%	≤0.5%
BREAKING STRENGTH	EN ISO 10545-4	≥1300N	≥1300N
MODULUS OF RUPTURE	EN ISO 10545-4	≥35N/mm <sup>2</sup>	≥35N/mm <sup>2</sup>
RESISTANCE TO ABRASION	EN ISO 10545-7	≤205mm <sup>3</sup>	≤160mm <sup>3</sup>
SLIP RESISTANCE, WET PENDULUM TEST METHOD, SLIDER 96	AS 4586-2013/AMDT 1-2017 APPENDIX A	N/A	P4
<b>CHEMICAL PROPERTIES</b>			
RESISTANCE TO CHEMICALS RESISTANCE TO HOUSEHOLD CHEMICALS AND SWIMMING POOL SALTS	EN ISO 10545-13	MINIMUM GB	<b>PASS</b>
RESISTANCE TO STAINING	EN ISO 10545-14 when subjected to chemicals	MINIMUM CLASS 3	<b>PASS</b>

## PACKING SPECIFICATIONS

SERIES	SIZES	PCS / CTN	M <sup>2</sup> / CTN	M <sup>2</sup> / PLT	CTN / PLT	KG / PLT
<b>CAPRI</b>	60X120CM	2	1.44	86.4	60	2070
	90X90CM	2	1.62	64.8	40	1520
	60X60CM	4	1.44	57.6	40	1240
	30X60CM	8	1.44	57.6	40	1240
	30X30CM	11	0.99	55.44	56	1232
	60X60X2CM	2	0.72	28.8	40	1280
	40X60X2CM	2	0.48	30.72	60	1440



There is no denying the grandeur of stone. Be inspired by our collection of stone designs, exclusively created to bring elegance and beauty to your home.





11TH FLOOR, BLDG T13, SMART CITY, NO.1 ZHIHUI RD.,  
CHANCHENG FOSHAN, GUANGDONG, CHINA.

+86 757 8256 5826

[www.paduaceramics.com](http://www.paduaceramics.com)